

Article number: 20516ND4327M5

Description: E+G Magnet - female thread GN 51.6-ND-43-27-M5  
Neodym, jern, bor - 80° C, 85N

## Measures

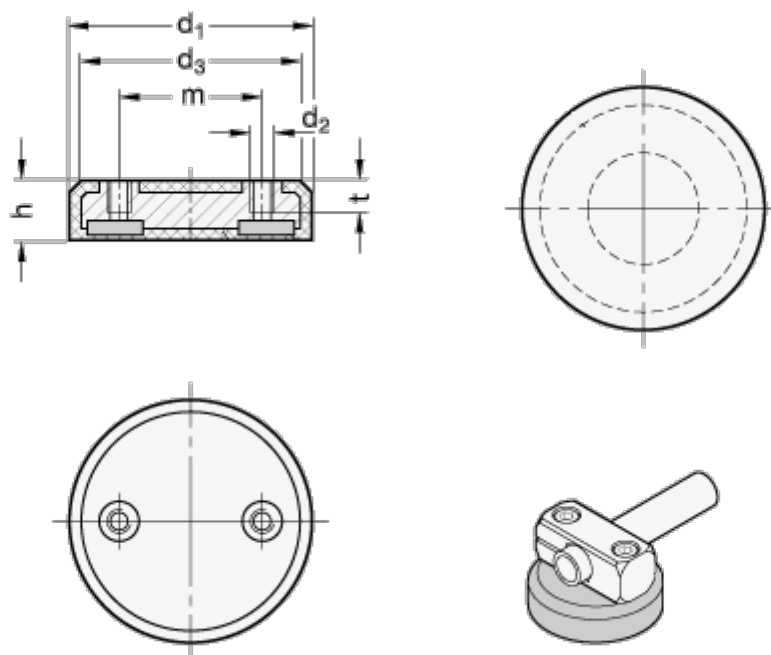

d1	= 43
d2	= M5
d3	= 39
h	= 10.3
Holding force N	= 85
m	= 27
t	= 7